

**Rajah 4.3 : Rajah Konteks**

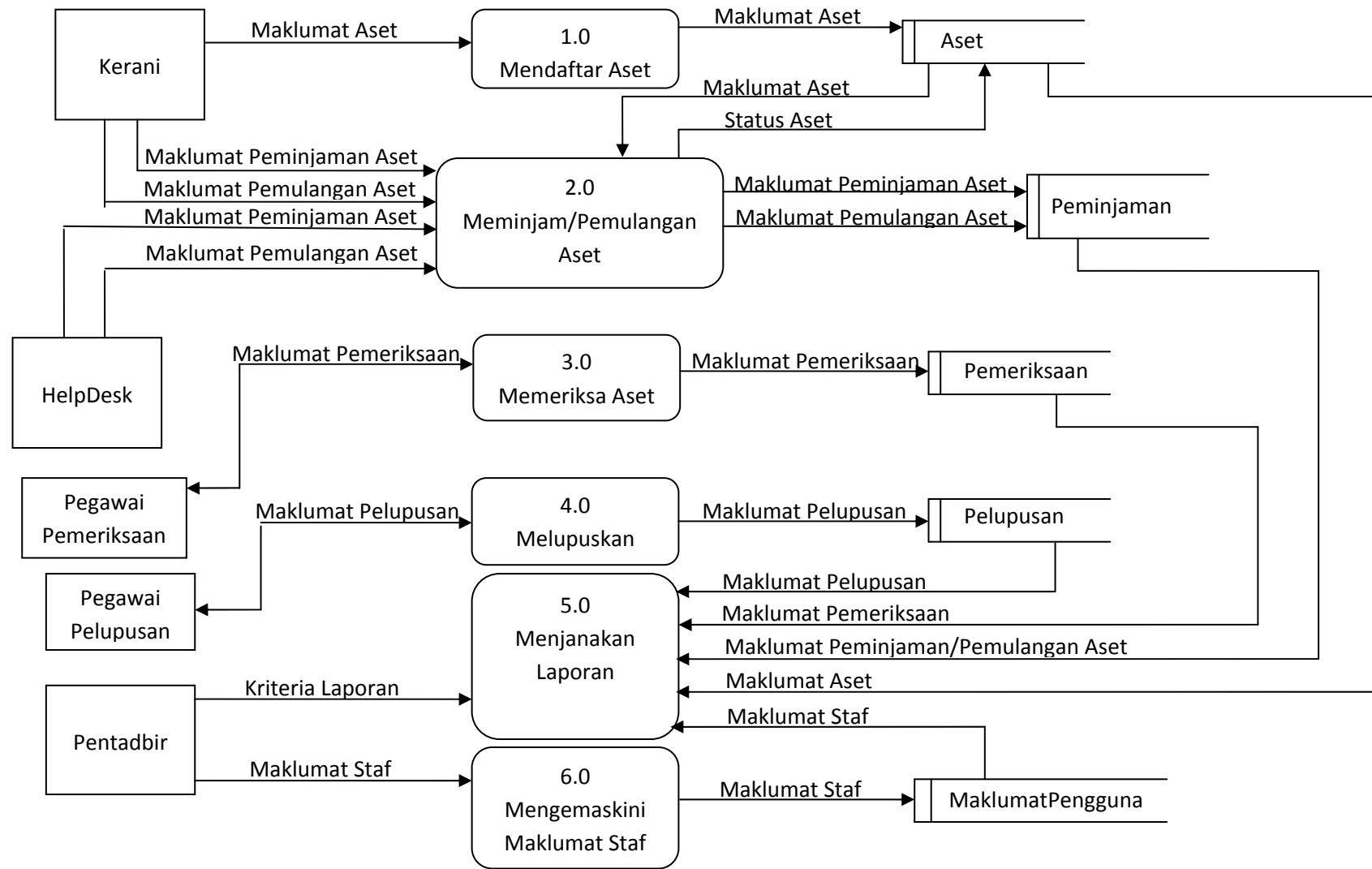

**Rajah 4.4 : Rajah Aliran Data Peringkat Sifar**

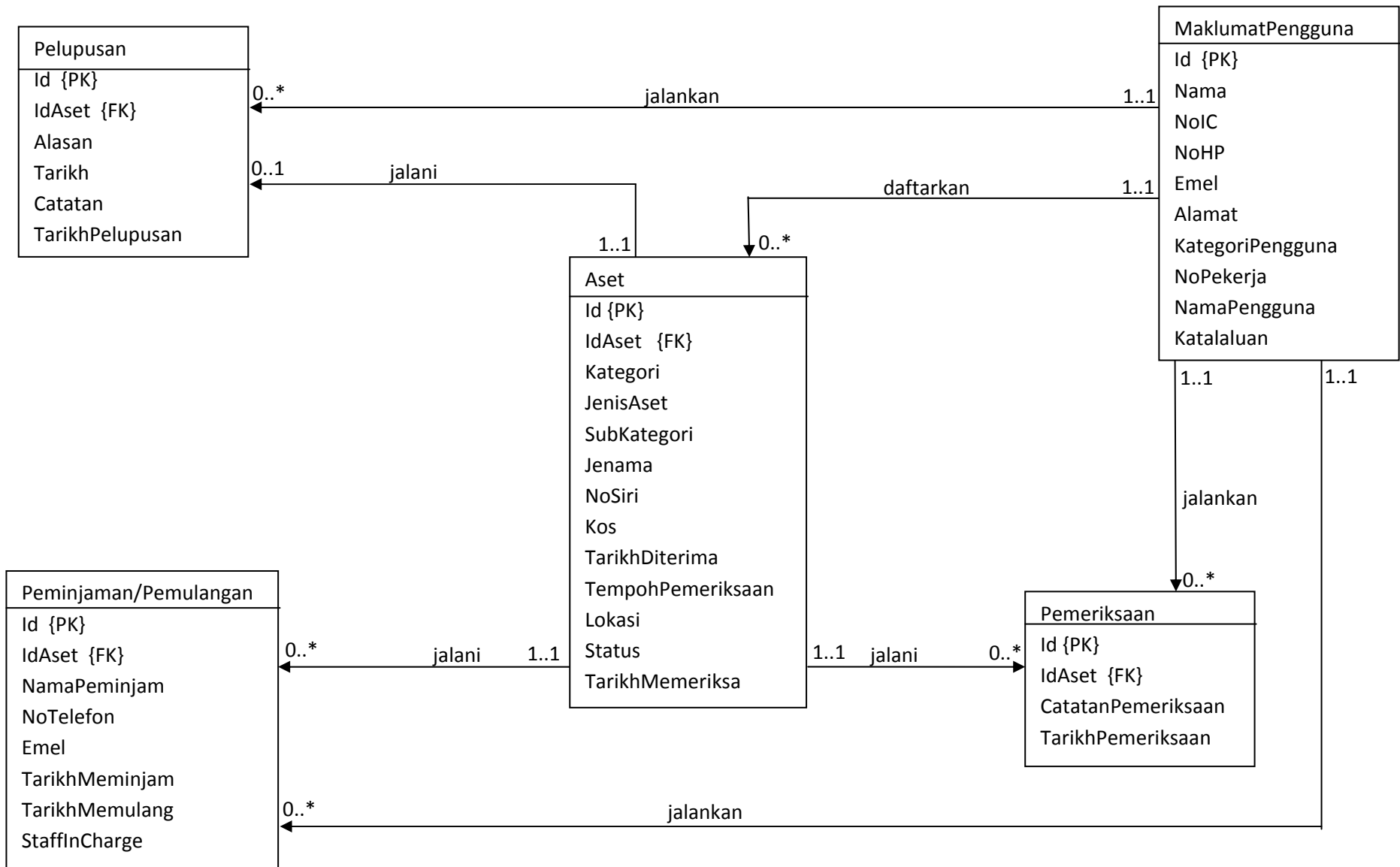

Rajah 4.5 : Rajah Hubungan Entiti

## CARTA GANTT

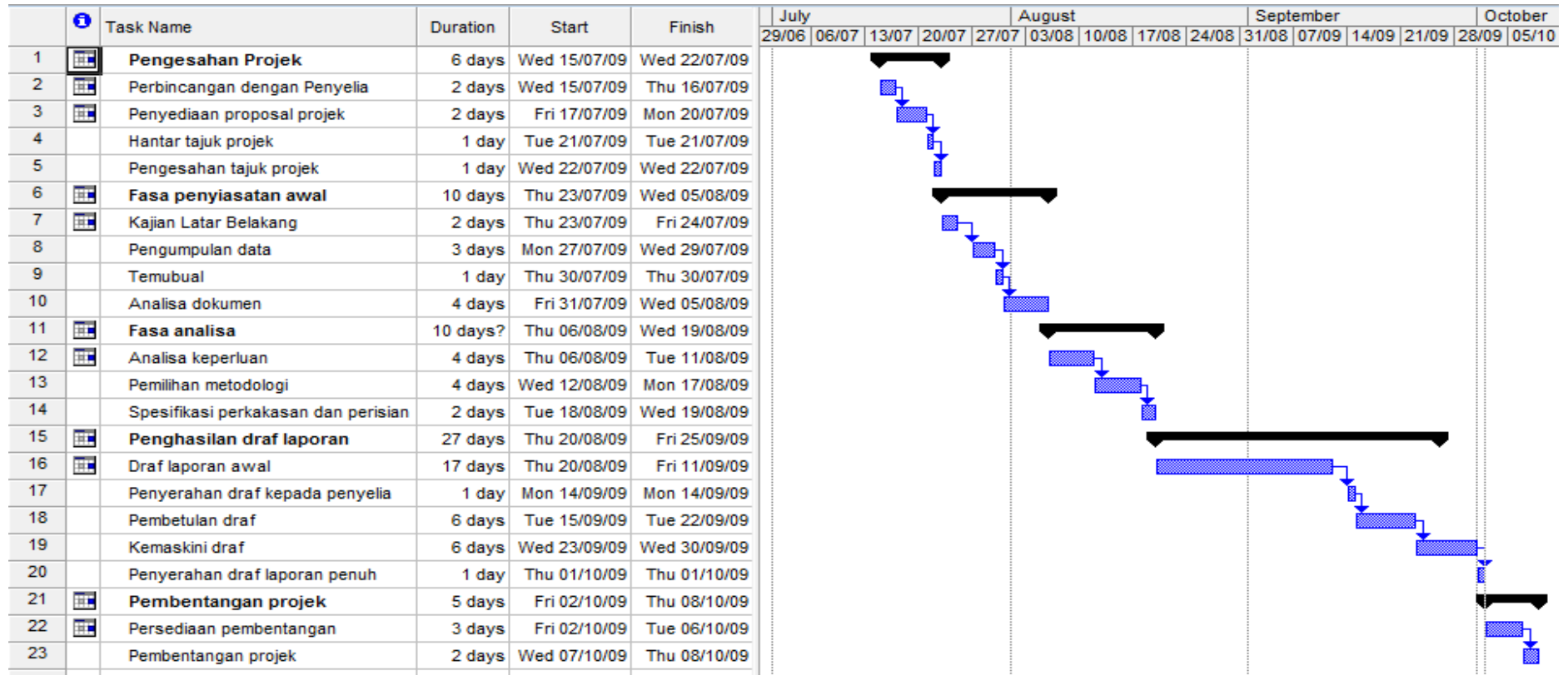

Project: gantt chart Date: Fri 02/10/09	Task		Milestone		External Tasks	
	Split		Summary		External Milestone	
	Progress		Project Summary		Deadline	

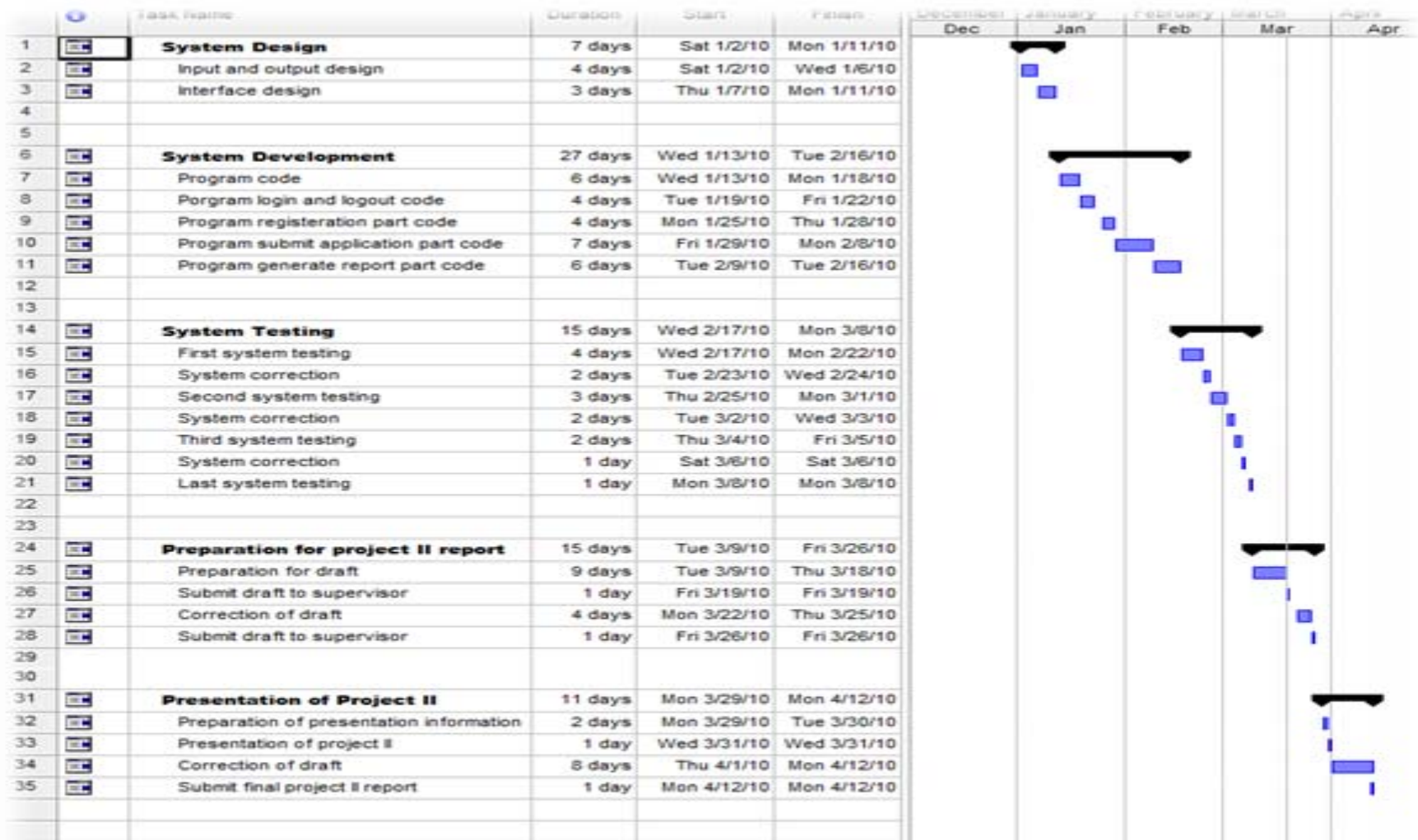

Project: Project2  
Date: Tue 9/29/09

Task		Milestone		External Task	
Split		Summary		External Milestone	
Project		Project Summary		Deadline	

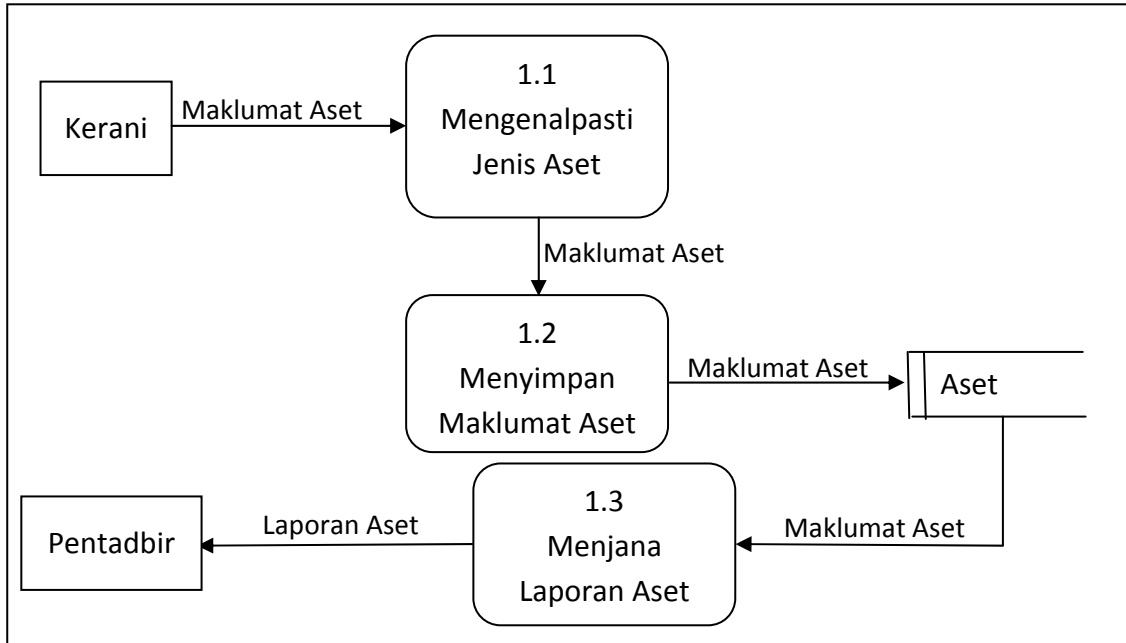

**Rajah DFD 1: Pendaftaran**

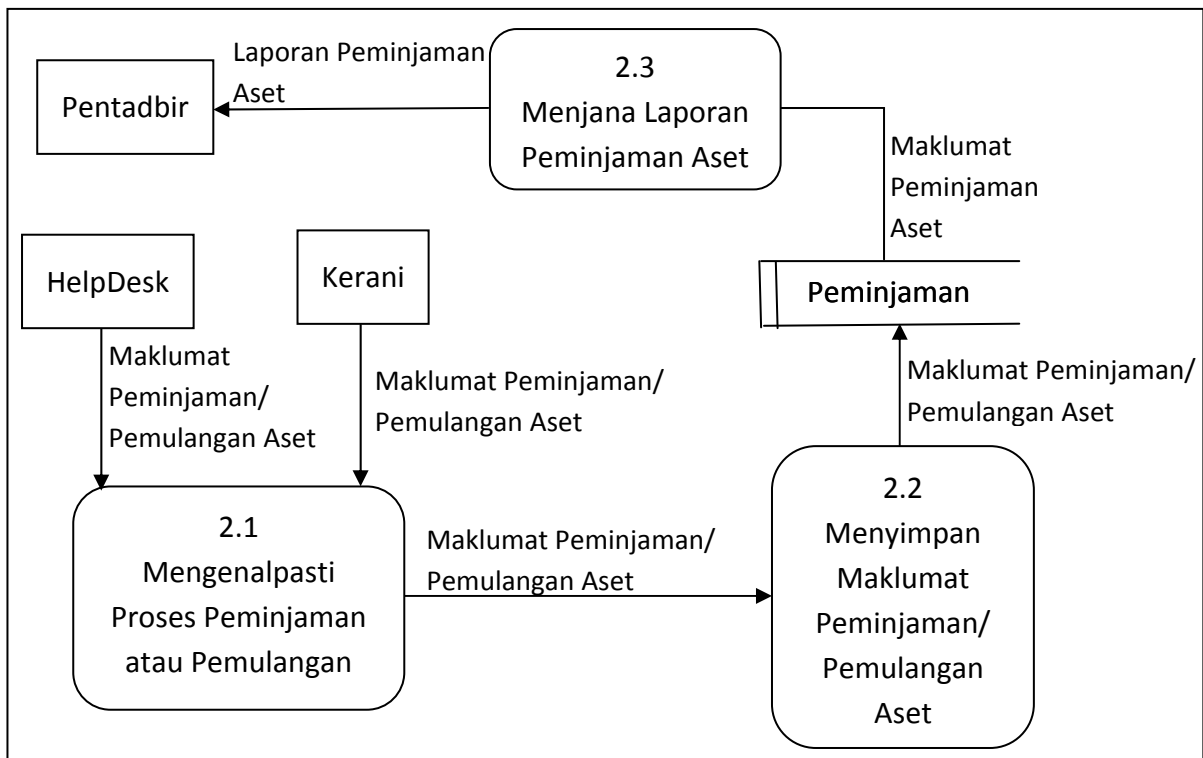

**Rajah DFD 2: Peminjaman/Pemulangan**

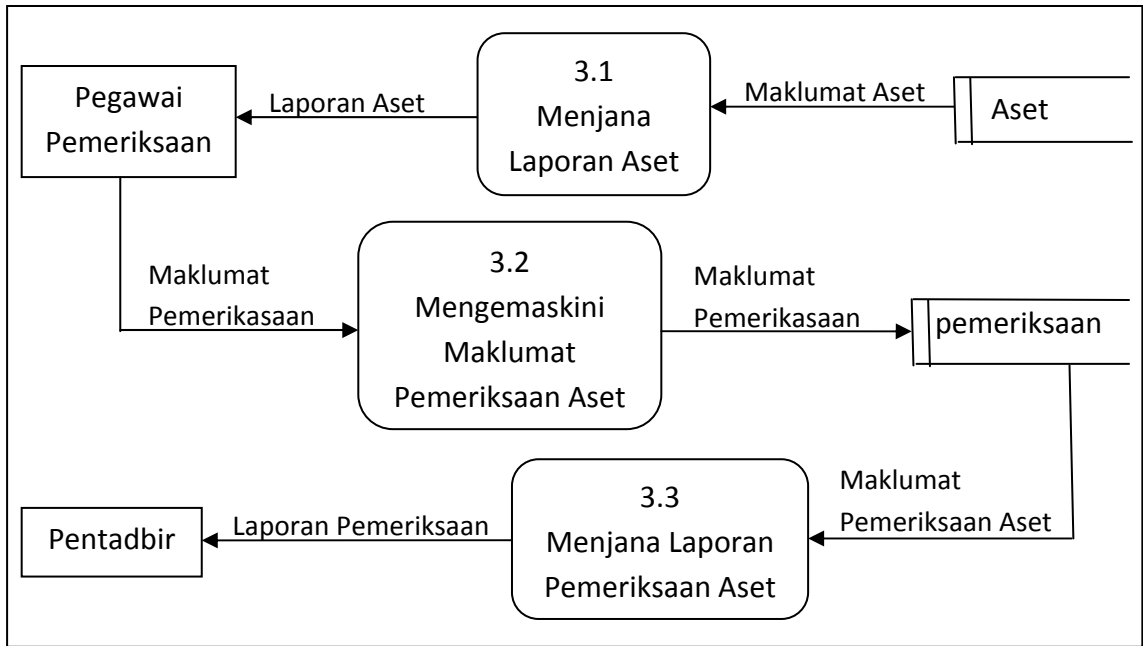

**Rajah DFD 3: Pemeriksaan**

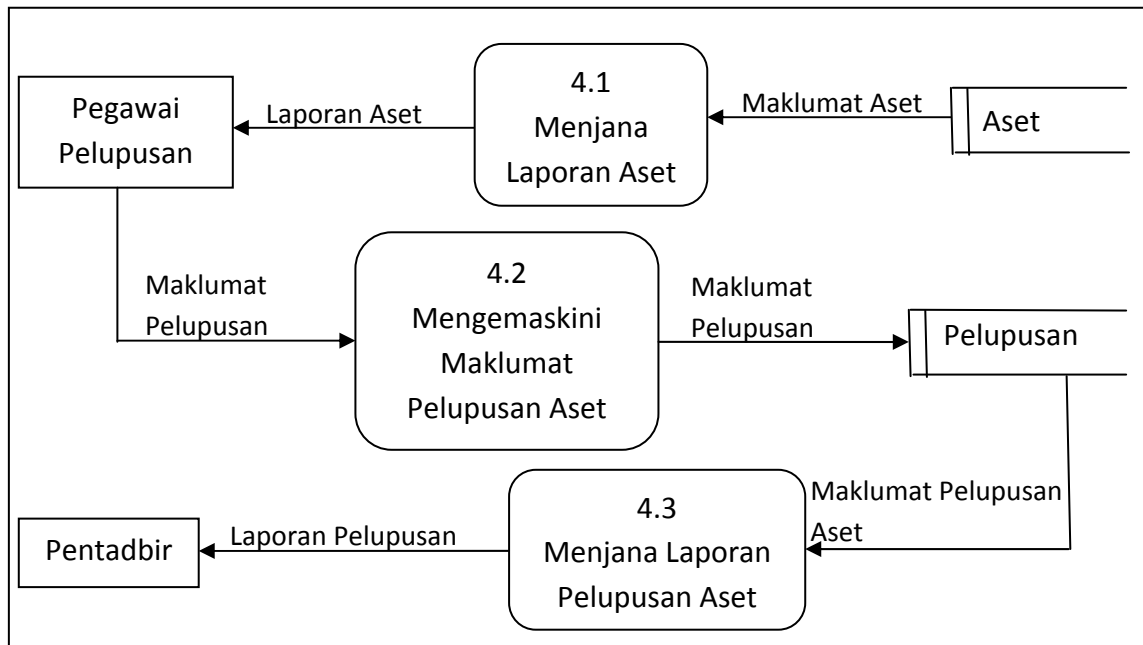

**Rajah DFD 4: Pelupusan**

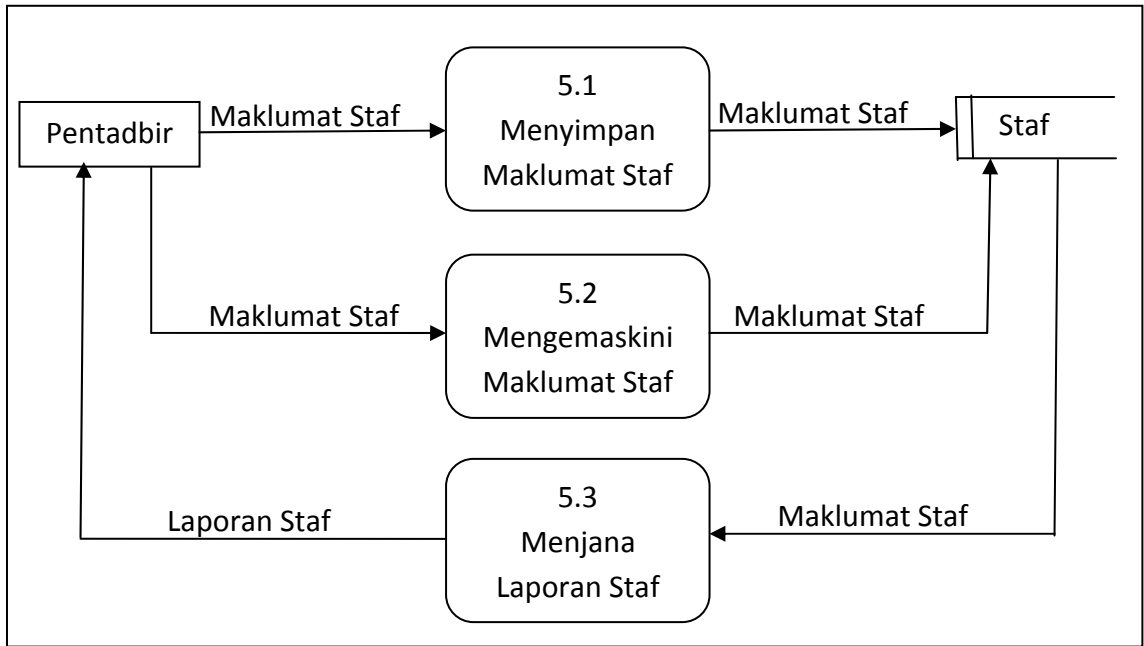

**Rajah DFD 5: Pentadbiran**